

BHN series

Paddle joystick controllers •
non-contacting Hall effect technology



DISTINCTIVE FEATURES

- Hall effect and switch function
- Custom levers available in 5 colors
- Analog or PWM outputs
- 5V operation with standard dual redundant outputs
- Sealed up to IP67



ENVIRONMENTAL SPECIFICATIONS

- Operating Temperature: -25 °C to +70 °C (-13 °F to +158 °F)
- Storage Temperature: -40 °C to +85 °C (-40 °F to +185 °F)
- Seal Above Panel: IP67
- EMC Immunity Level: EN61000-6-2: 2005
- EMC Emissions Level: EN61000-6-4: 2011
- ESD: EN61000-4-2
- Damp Heat – BS EN 60068-2-78:2002
- Salt Spray – BS EN 60068-2-11:1999
- Thermal shock: BS EN 60068-2-14:2009
- Humidity cycling BS EN 60068-2-38:2009
- Signal Cable Transients: EN 61000-6-2: 2005
- AC Magnetic Field Immunity: MIL-STD-461F
- Random vibration according to BS EN 60068-2-64:1008
- BS EN 60068-2-27:2009
- Freefall drop - BS EN 60068-2-31:2008
- Shock (acceleration) - BS EN 60068-2-27:2009



ELECTRICAL SPECIFICATIONS

- Maximum Voltage: 5 V \pm 0.5 V Transient free
- Recommended load: 10 K Ω Minimum
- Return to Center Voltage Tolerance: $V/2 \pm$ (5% x Gain)

The company reserves the right to change specifications without notice.



BHN series

Paddle joystick controllers •
non-contacting Hall effect technology



MECHANICAL SPECIFICATIONS

- Mechanical Angle of Movement: $\pm 30^\circ$
- Expected Mechanical Life:
 - 10 million cycles - sprung only
 - 2 million cycles - detent
- Mass/weight: 50 g (1.76 oz.)
- Lever action: Sprung to centre and detent options



MATERIALS

- Body: PA
- Actuator: PA & PC
- Rubber Grip: TPE



CONNECTIONS

- The paddle is fitted, as standard, with an industry standard 2.54mm pitch 8 way connector.
- Fitted Toby 2542-RR-08-T, mating connector Toby AM254-075-010 or equivalent

PIN	FUNCTION
1	5 V
2	Blank
3	0 V
4	Analog/PWM output 1
5	Analog/PWM output 2
6	0 V
7	Blank
8	5 V

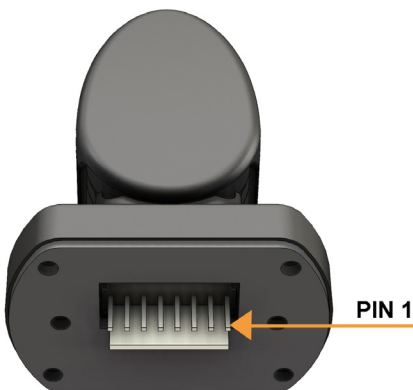

PANEL CUT-OUT

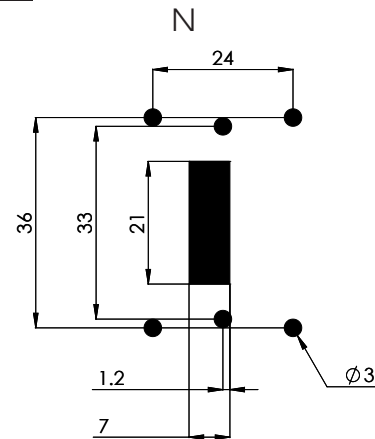

Viewed front of panel



MOUNTING



- The paddle may be mounted with all 6 screws or just the corner screws. Screws must be torqued to 0.4 Nm. The M3 inserts are 6 mm deep.
- Fasteners are not supplied as standard. The appropriate length of fastener is dependent on panel thickness.

Paddle joystick controllers •
non-contacting Hall effect technology



OUTPUT SPECIFICATIONS

40% GAIN INVERSE

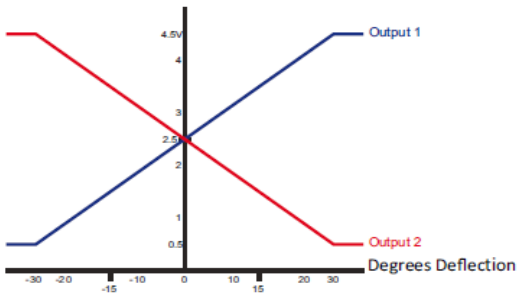

40% GAIN

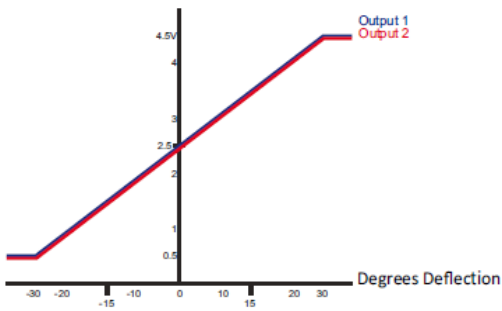

BHN series

Paddle joystick controllers •
non-contacting Hall effect technology



BUILD YOUR PART NUMBER

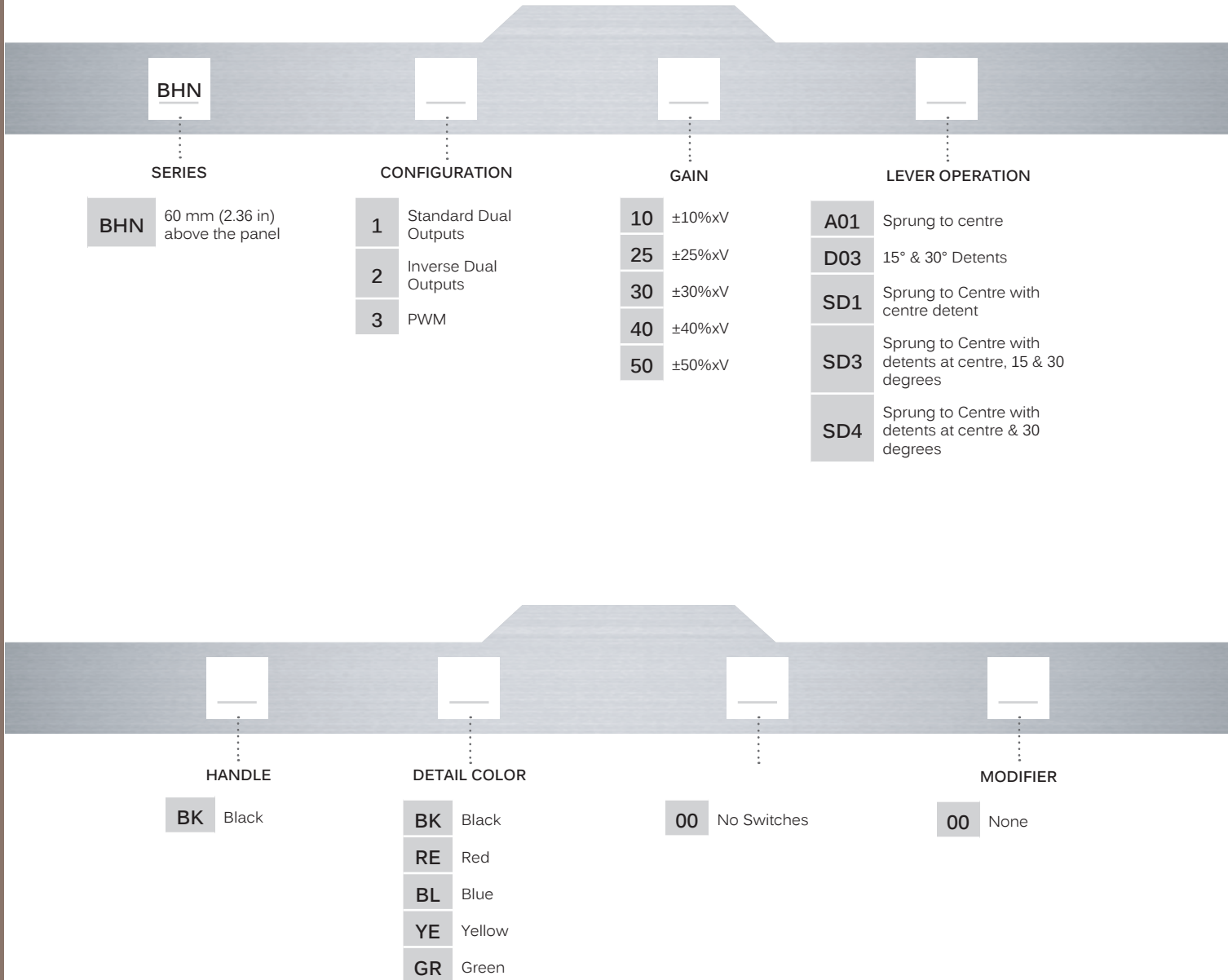

Paddle joystick controllers • non-contacting Hall effect technology

DIMENSIONS

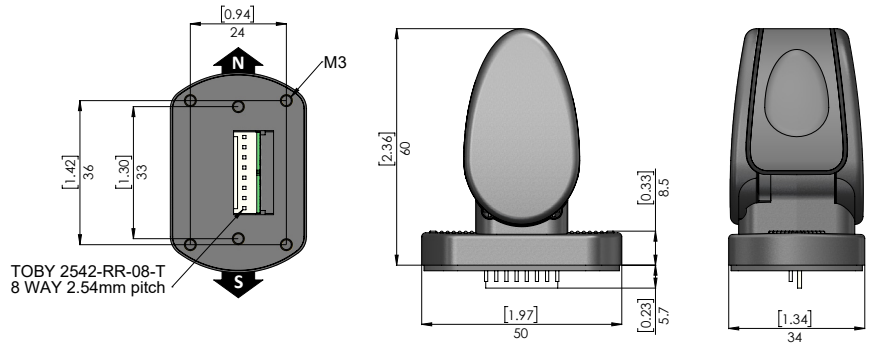

VOLTAGE OUTPUT OPTIONS

DUAL OUTPUT CONFIGURATION 1

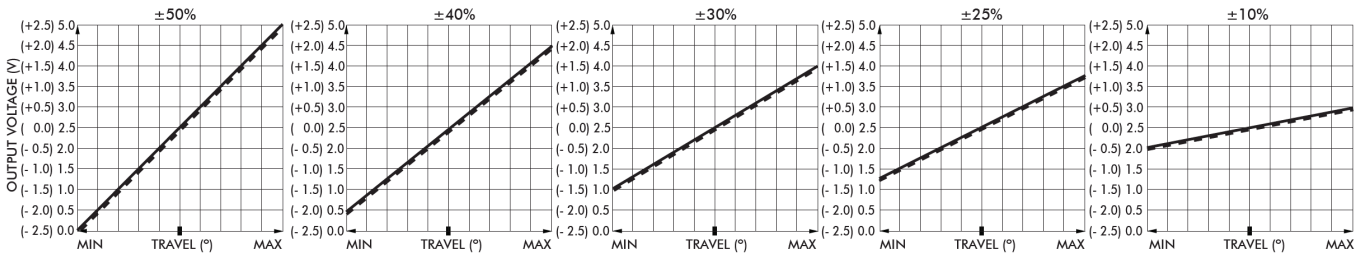

DUAL OUTPUT CONFIGURATION 2

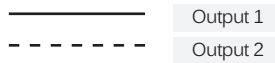
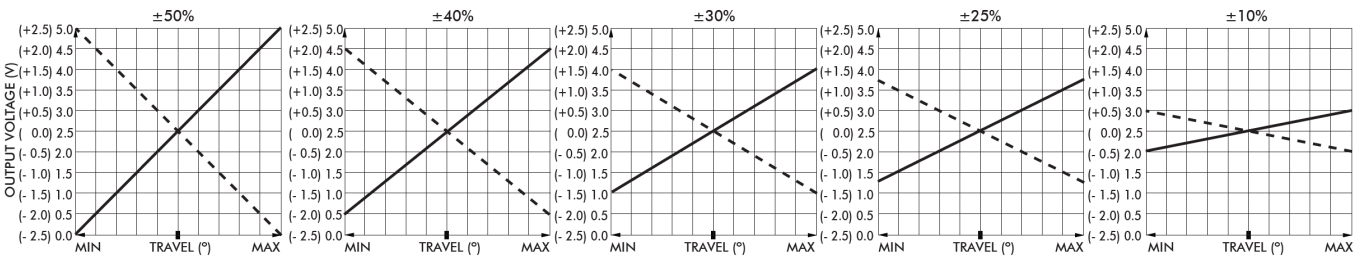

LEVER OPERATION OPTIONS

DETENT

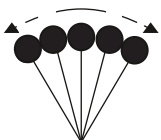

D03 +/- 15&30 degrees

SPRING TO CENTER WITH DETENT OPTIONS

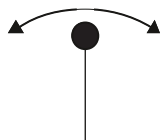

SD1 Center detent

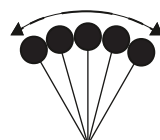

SD3 +/- 15&30 degrees

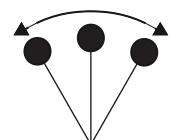

SD4 +/- 30 degrees

BHN series

Paddle joystick controllers •
non-contacting Hall effect technology



CONFIGURATION

OUTPUT OPTIONS

The BHN series paddle joystick is configured as two “electrical” controls in one mechanical package. The Paddle operates from 5V and provides two proportional outputs. The second output is accurate to the first within $\pm 3\%$ of the power supply. The power supply for the secondary output is also completely independent. Customers may choose their preference of voltage outputs (gains).

The secondary output can be of the same or inverse polarity to the primary wiper. For example, with a secondary inverse output, the first and second outputs can be summed and compared to zero to verify that the joystick is operating correctly. Paddles having two identical outputs of the same polarity may be used to drive two identical dual redundant circuits.

The BHN series paddle joystick may be specified with a variety of PWM output options. For more details on available PWM options please refer to APEM

GAIN OPTIONS

The voltage output on the wiper, at full scale deflection is determined by the gain. The gain is expressed as a percentage of the voltage supplied. Therefore (assuming a 5 V supply) a Paddle specified with $\pm 25\%$ gain would yield 1.25 V at South, 2.5 V at center and 3.75 V at North. A range of gain options are available as standard.

All controls are supplied pre-set and no further calibration is needed throughout the lifetime of operation.

OUTPUT IMPEDANCE

The voltage outputs at center and at each end of travel are specified across an infinite load, with no current flowing. The output impedance specified in the electrical specification should be taken into account when designing a system. Load resistance of less than 10 K Ohms is not recommended.

POWER SUPPLY

The BHN is designed to be powered by a regulated $5V \pm 0.5V$ power supply. The outputs are ratiometric, making a stable, noise free, power supply essential. The power supply to the joystick should be carefully regulated to be within tolerance. Should the power supply change outside of the specified tolerances, permanent damage may occur.

MAGNETIC IMMUNITY AND SYSTEM DESIGN

The BHN Series incorporates internal magnetic screening to minimize the effect of external magnetic fields. Mounting or operating the Paddle close to strong magnetic fields is not recommended. System designers should follow best practice when incorporating the BHN Series Paddle into their products. Care should be taken to decouple the power supply properly and to employ adequate EMC shielding.

MOUNTING

When mounting the Paddle, care should be taken to site it in a position that does not make vulnerable to damage when in use. If the Paddle is intended for use in a handheld enclosure then care must be taken to protect the Paddle from damage caused by dropping. For long term reliability, basic precautions should be implemented, such as mounting it at the lightest end of the enclosure or by protecting it with a guard.

The body of the Paddle, on the underside of the panel, must not be subject to water spray, excessive humidity or dust.