

# KL series

Locking power rocker switches



## DISTINCTIVE FEATURES

- One protected position
- Patented intuitive ergonomics
- Laser etched symbols
- Illuminated or non-illuminated
- Optionally sealed to IP69K



## ENVIRONMENTAL SPECIFICATIONS

- Sealing options :
  - K : IP68 to front panel components of switch only according to IEC 60529
  - Z : IP69K panel sealing according to DIN 40050-9
- Salt spray resistance : 96 hours according to IEC 512-6, test 11f
- Operating temperature : -40 °C to +85 °C (-40 °F to +185 °F)



## ELECTRICAL SPECIFICATIONS

- Current/voltage rating with resistive load :
  - Silver plated contacts :
    - A : 5 A 24 VDC, 100,000 cycles
    - 10 A 24 VDC, 10,000 cycles (terminals 6.35 x 0.8 only)
    - S : 20 A 12 V, 10,000 cycles (see "Build your part number")
  - Gold plated contacts (D) : 20 mA 12 V, 150,000 cycles
- Initial contact resistance : 10 mΩ max.
- Insulation resistance : 1,000 MΩ min. at 500 VDC
- Dielectric strength : 2,000 Vrms 50 Hz min. between terminals
- Mechanical life : 150,000 cycles min.



## GENERAL SPECIFICATIONS

- Mechanical life : 150,000 cycles min.
- Panel thickness : 0.8 mm to 4.6 mm
- Recommended panel thickness : between 2 mm and 3.5 mm

The company reserves the right to change specifications without notice.



# KL series

Locking power rocker switches

## MATERIALS

- Case : PA 6-6
- Actuator : ABS
- Unlocking actuator : ABS or elastomeric membrane
- Bezel : PA 6-6
- Contacts & terminals : brass, solid silver grain, silver plated (A or S) or brass, solid silver grain, gold plated (D)
- Contact roller : brass, nickel plated

APEM products may be recycled at end-of-life for the re-claiming of valuable metal components.

## SEALING

- Sealing is optional. To order a sealed product, complete the appropriate box of ordering format on the following pages.

## MATRIX MOUNTING

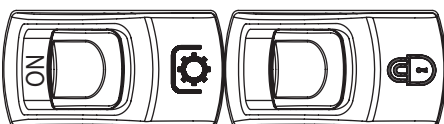
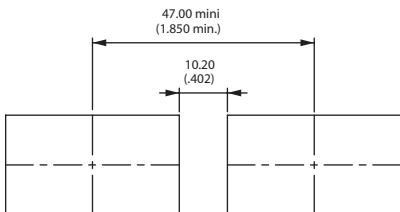
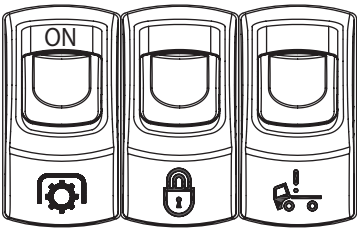
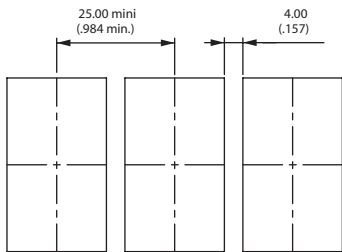

## PANEL CUT-OUT

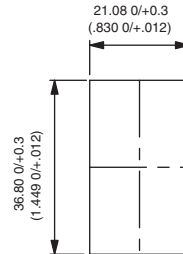

## SPECIFIC MATRIX MOUNTING FOR Z VERSION

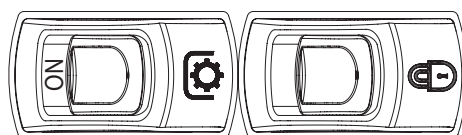
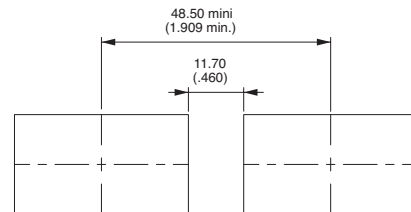
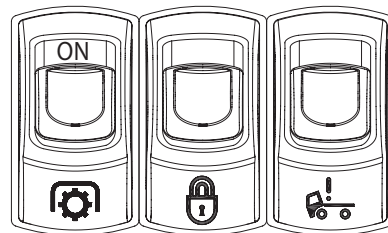
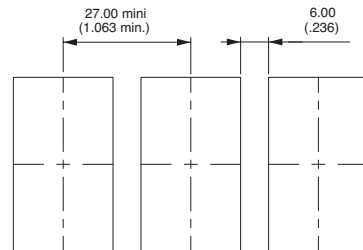



### ELECTRICAL FUNCTIONS AND CONNECTIONS

In the tables below, terminal connections as viewed from bottom of switch. Only the contact area is represented. For single pole models, only terminals 1, 2 and 3 are to be considered (not 6, 5, 4).

x = w/o terminal  
o = with terminal  
▲ = momentary

#### 2 POSITIONS

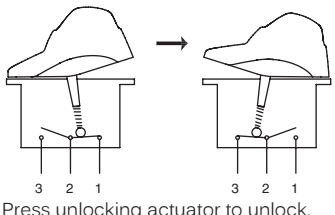

Function 1 * KL31-KL41		
Function 5 KL35 - KL45		
Function 6 KL36-KL46		

\* Function 1 : Only available for 6 terminal versions, illuminated versions only available with "A" wiring.

#### 3 POSITIONS

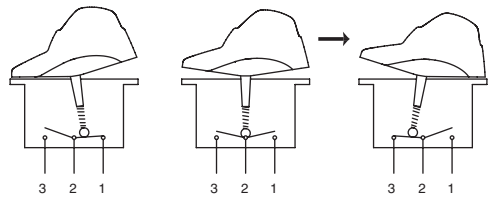

Function 7 KL37-KL47			
Function 8 KL38-KL48			
Function 9 KL39-KL49			
Function 4 KL44			
Function 4-1R KL44-1R			



### TERMINALS

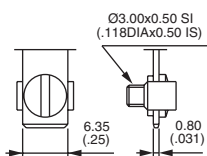

Screw

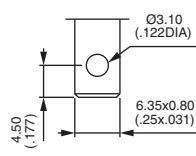

Solder lug / quick-connect

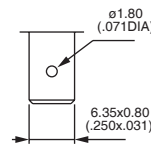

Normalized quick-connect 6.35x0.8

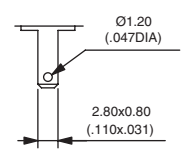

Normalized quick-connect 2.8x0.8

# KL series

Locking power rocker switches



## BUILD YOUR PART NUMBER

To order a complete product, fill in all the boxes of the following order guide.

### CASE + LEADS



#### SERIES

KL

#### POLES

- 3** Single pole
- 4** Double pole

#### ELECTRICAL FUNCTIONS

<b>1</b>	ON	-	OFF
<b>4</b>	ON	ON	ON
<b>4-1R</b>	ON	ON	MOM
<b>5</b>	MOM	-	ON
<b>6</b>	ON	-	ON
<b>7</b>	MOM	OFF	MOM
<b>8</b>	ON	OFF	MOM
<b>9</b>	ON	OFF	ON

Function 1 only for 6-terminal versions.  
Functions 5 and 6 cannot be combined with "H" wiring.

#### CONTACTS

- A** Silver
- D** Gold plated
- S** Silver 20 A\*\*\*

#### SEALING

- X** No
- K** IP68
- Z** IP69K

#### LEDS

- X** None
- A** LED 6 V red
- B** LED 6 V green
- C** LED 6 V yellow
- M** LED 6 V blue
- R** LED 6 V white
- D** LED 12 V red
- E** LED 12 V green
- F** LED 12 V yellow
- N** LED 12 V blue
- S** LED 12 V white
- J** LED 24 V red
- K** LED 24 V green
- L** LED 24 V yellow
- P** LED 24 V blue
- T** LED 24 V white

See following pages.

etc.

#### TERMINALS

##### Screw

- 0** 6 terminals with barrier

##### Solder lug/quick-connect

- 2** 6 terminals with barrier
- 4** 6 terminals w/o barrier
- A** 10 term. with barrier
- B** 10 term. w/o barrier
- C** 10 terminals for use with connector U2292 or U3152

##### Normalized quick-connect 6.35x0.8

- 3** 6 terminals with barrier
- 5** 6 terminals w/o barrier
- D** 10 term. with barrier
- E** 10 term. w/o barrier
- F** 10 term. for use with connector U2292 or U3152

##### Normalized quick-connect 2.8x0.8

- G** 10 term. with barrier
- H** 10 term. w/o barrier
- J** 10 terminals for use with connector U2282

\*\*\* S contacts for all functions except 5 and 4-1R - for normalized quick-connect terminals 6.35x0.8 only.

### ACTUATOR

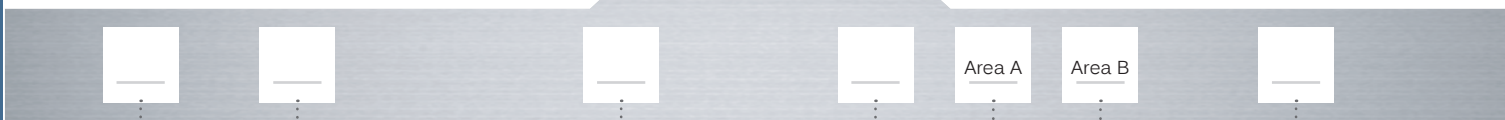

#### TYPE

- 1** For non-illuminated application
- 2** For illuminated application

#### UNLOCKING ACTUATOR COLOR

##### Hard plastic (ABS)

- 1** Blue
- 1/4** Dark blue
- 2** Black
- 3** Green
- 4** Grey
- 5** Yellow
- 6** Red
- 7** Ivory
- 9** Orange

##### Elastomer

- Y** Yellow
- R** Red
- G** Green
- W** White

#### SYMBOLS

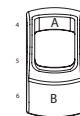

#### MARKING COLOR

##### Illuminated models

- Blank** White

##### Non-illuminated

- 1** Blue
- 2** Black
- 3** Green
- 4** Grey
- 5** Yellow
- 6** Red
- 7** White
- 9** Orange

#### ROCKER COLOR

- 1** Blue
- 1/4** Dark blue
- 2** Black
- 3** Green
- 4** Grey
- 5** Yellow
- 6** Red
- 7** Ivory
- 9** Orange

#### MARKING ORIENTATION



Symbols & Accessories : see end of the series.

NOTICE : please note that not all combinations of above numbers are available. Refer to following pages for further information.

# KL series

## Locking power rocker switches

### 6 TERMINAL VERSION



	Single pole	Double pole	2-3 5-6	1-2 4-5
KL31	KL41	ON	-	OFF
	KL44*	ON	ON	ON
	KL44-1R*	ON	ON	MOM
	KL45	MOM	-	ON
KL36	KL46	ON	-	ON
KL37	KL47	MOM	OFF	MOM
KL38	KL48	ON	OFF	MOM
KL39	KL49	ON	OFF	ON

\*Function 4 and 5 : single pole in double pole case

### 10 TERMINAL VERSION



	Single pole	Double pole	2-3 5-6	1-2 4-5
KL31	KL41	ON	-	OFF
	KL44*	ON	ON	ON
	KL44-1R*	ON	ON	MOM
	KL45	MOM	-	ON
KL35	KL46	ON	-	ON
KL36	KL47	MOM	OFF	MOM
KL37	KL48	ON	OFF	MOM
KL38	KL49	ON	OFF	ON
KL39	KL49	ON	OFF	ON

\*Function 4 : single pole in double pole case

→ FLAT SEAL  
47.00  
(1.850)

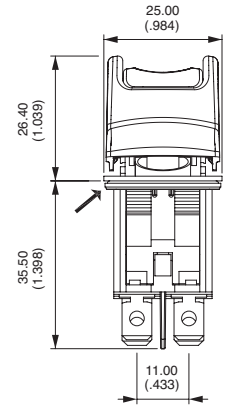
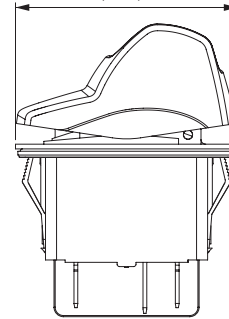

→ FLAT SEAL  
47.00  
(1.850)

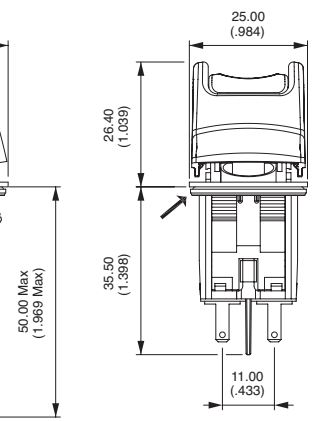
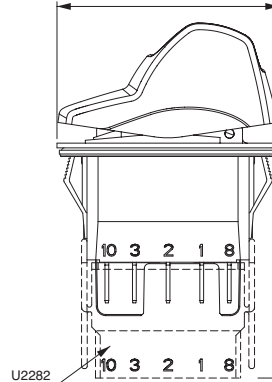

### CASE + LEDS

### TERMINALS

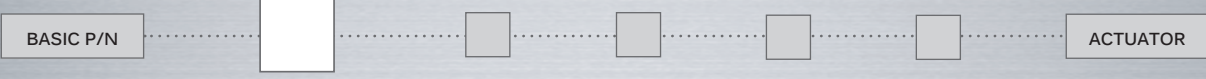

### SCREW

0 6 terminals with barrier

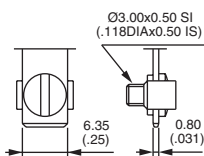

screw

### SOLDER LUG / QUICK-CONNECT

- 2 6 terminals with barrier
- 4 6 terminals w/o barrier
- A 10 terminals with barrier
- B 10 terminals w/o barrier
- C 10 terminals for use with connector U2292 or U3152

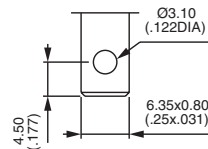

Solder lug / quick-connect

# KL series

Locking power rocker switches

## CASE + LEDS



## TERMINALS (CONTINUED)

### NORMALIZED QUICK-CONNECT 6.35X0.8

- 3 6 terminals with barrier
- 5 6 terminals w/o barrier
- D 10 terminals with barrier
- E 10 terminals w/o barrier
- F 10 terminals for use with connector U2292 or U3152

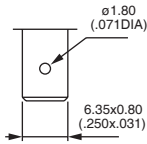

Normalized quick-connect 6.35x0.8

### NORMALIZED QUICK-CONNECT 2.8X0.8

- G 10 terminals with barrier
- H 10 terminals w/o barrier
- J 10 terminals for use with connector U2282

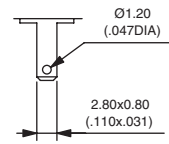

Normalized quick-connect 2.8x0.8

### 6 TERMINAL VERSION

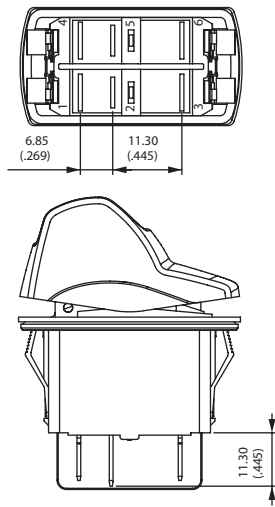

### 10 TERMINAL VERSION

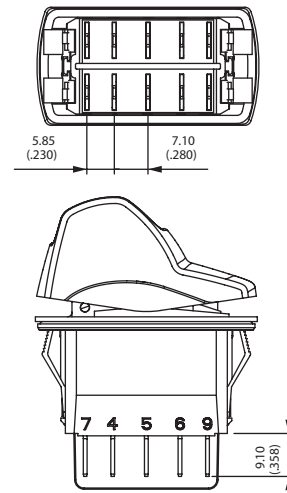

Terminals are marked on the case. The drawings show the maximum possible number of terminals.

## CASE + LEDS



## CONTACT MATERIALS

- A Silver
- D Silver, gold plated
- S Silver 20A. For all functions except 4 and 4-1R - for normalized quick-connect terminals 6.35x0.8 only.

# KL series

Locking power rocker switches

## CASE + LEDS

## SEALING



- X No sealing
- K IP68 (front panel components of switch only)
- Z IP69K - Installation notice available on request

Ultrasonic welding of frame to case is standard on all versions. The ultrasonic welding and the optional panel seal prevent water and dust from introducing into the switch housing.

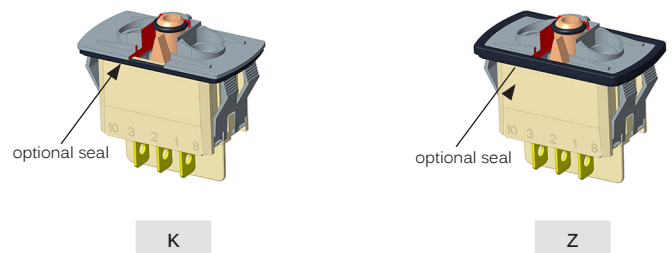

## CASE + LEDS

## LEDS



Complete enlarged box with one of the codes listed below.

- X Without LED

	Red	Green	Yellow	Blue	White	Amber	Red/green
6 VDC	A	B	C	M	R	4	1
12 VDC	D	E	F	N	S	5	2
24 VDC	J	K	L	P	T	6	3
No resistor	U	V	W	Y	Z	9	8

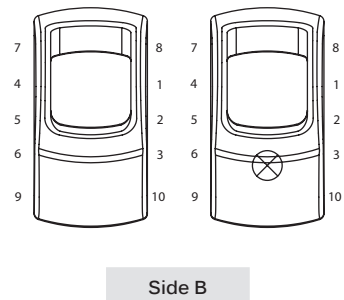

LED consumption : 20 mA @ nominal voltage (25 °C / 77 °F)  
Other illumination solutions : on request.

For non-stabilized on-board power supplies submitted to potential voltage surges due to the alternator, 15 V and 30 V LED configurations are also available on request. LED Tolerance ±10 %

## CASE + LEDS

## WIRING

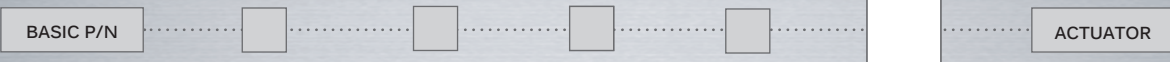

The LED wiring diagram is shown on the case.

FOR 6 TERMINAL VERSIONS - LED CONNECTED TO THE LOAD

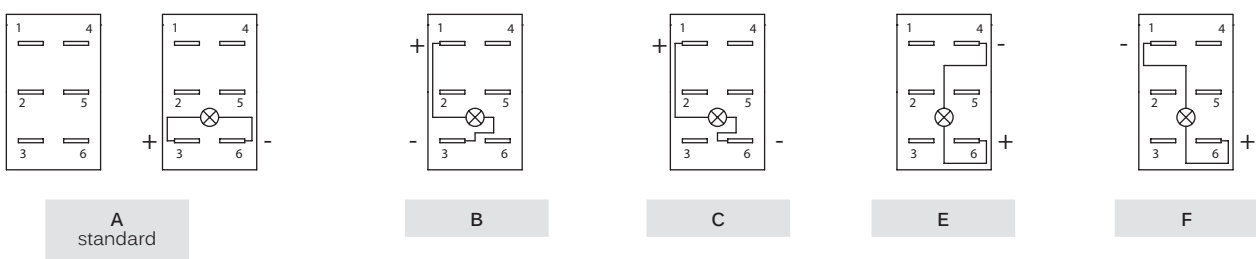

Note : If not available, terminals are added to connect the LED.



# KL series

## Locking power rocker switches

### CASE + LEADS

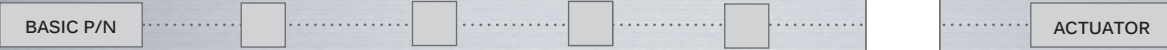

FOR 10 TERMINAL VERSIONS - INDEPENDENT LED OR INTEGRATED FUNCTIONS

- G** Standard, to have independent LED.
- H** To obtain 2 symbol illumination levels (night illumination when OFF and higher illumination when ON).  
*Dotted line = external wiring, continuous line = internal wiring*  
Available in Single Pole only, with H and J quick-connect terminals
- I** To have a polarity inversion (typical application : fan motor).  
*Dotted line = external wiring*  
Power supply between 2 and 5 - Load between 1 and 4 or 3 and 6.  
Available with H and J quick-connect terminals.

Please contact us for other wiring solutions.

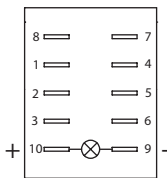

G

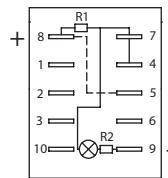

H

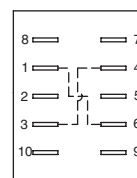

I

### ACTUATOR

### ACTUATOR TYPE



- 1 For non-illuminated application
- 2 For illuminated application

### ACTUATOR

### ROCKER COLOR



- 1 Blue
- 1/4 Dark blue
- 2 Black
- 3 Green
- 4 Grey
- 5 Yellow
- 6 Red
- 7 Ivory
- 9 Orange

Note : color 7 not available on illuminated versions



# KL series

Locking power rocker switches

## ACTUATOR

## UNLOCKING ACTUATOR



### HARD PLASTIC (ABS)

1	Blue	5	Yellow
1/4	Dark blue	6	Red
2	Black	7	Ivory
3	Green	9	Orange
4	Grey		

### ELASTOMER

Y	Yellow
R	Red
G	Green
W	White

## ACTUATOR

## MARKING ORIENTATION



If no marking required, complete the box with code N.  
Other orientations : on request

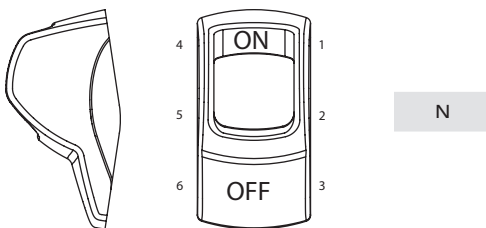

## ACTUATOR

## SYMBOLS



XX No symbol

If no marking required, end up the part number with Actuator marking orientation (see above)

### Available symbols

Complete each enlarged box with the one of the codes listed on the following pages.

### Laser etching resistance

- Water and petrol resistant according to EN61058-1
- Tear resistant (cross-cut test) according to NF ISO 2409 : class 0
- UV resistant according to ISO 4892-2

### Marking area

The symbol will be included in the hatched area.

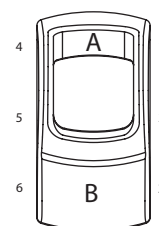

# KL series

Locking power rocker switches

For illuminated versions

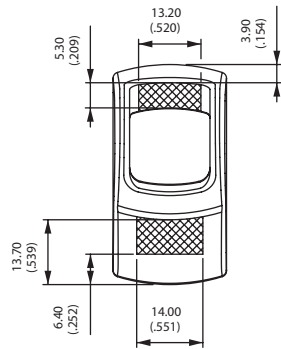

For non-illuminated versions

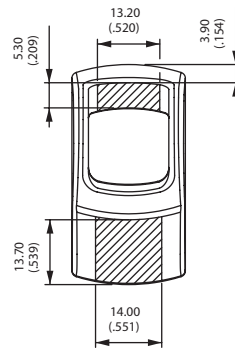

ACTUATOR

MARKING COLOR



ILLUMINATED MODELS - LASER ETCHING

Blank White

NON-ILLUMINATED MODELS - PAD PRINTING

- 1 Blue
- 2 Black
- 3 Green
- 4 Grey
- 5 Yellow
- 6 Red
- 7 White
- 9 Orange