

# 6000 series

Toggle switches for rugged and demanding applications



## DISTINCTIVE FEATURES

Sealing and locking lever options available  
Black finish on actuator and bushing



## ELECTRICAL SPECIFICATIONS

- Max. current/voltage rating : see table below
- Initial contact resistance : 10 mΩ max.
- Insulation resistance : 1,000 MΩ min. at 500 VDC
- Dielectric strength :  
2,000 Vrms 50 Hz min. between terminals  
3,000 Vrms 50 Hz min. between terminals and frame
- Electrical life : 10,000 cycles at full load

Current/Voltage Rating	
Resistive load	6.5 A 30 VDC
Inductive load	5 A 30 VDC
Lamp load	3 A 30 VDC



## GENERAL SPECIFICATIONS

- Torque : 1.50 Nm (1.10 Ft.lb) max. applied to nut
- Panel thickness : 5 mm (.196) max.
- Operating temperature : -40 °C to +85 °C (-40 °F to +185 °F)



## MATERIALS

- Case : diallylphthalate (DAP)
- Actuator : brass, chrome plated, black
- Bushing : brass, chrome plated, black
- Contacts : A : silver

The company reserves the right to change specifications without notice.



# 6000 series

Toggle switches for rugged and demanding applications

## ELECTRICAL FUNCTIONS

→ KEYWAY

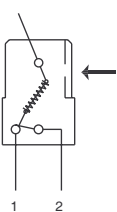

1 pole

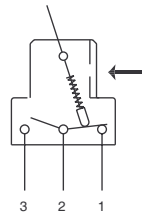

2, 3, and 4 pole

## TERMINALS

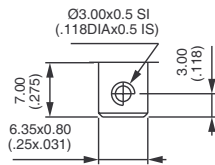

## STANDARD PANEL CUT-OUT

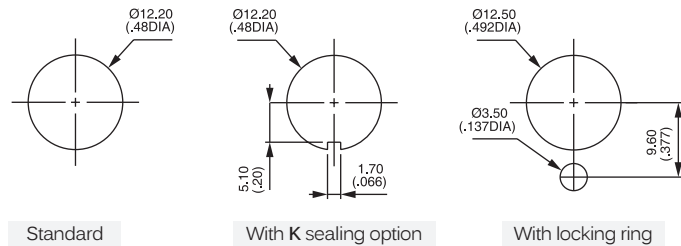

Standard

With K sealing option

With locking ring

## PANEL CUT-OUT WITH "K" SEALING

Recommended cut-out and mounting depending on panel thickness

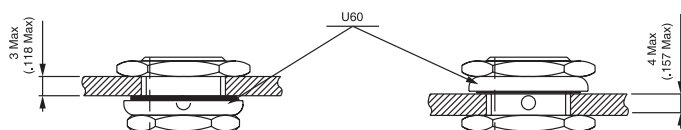

# 6000 series

Toggle switches for rugged and demanding applications



## BUILD YOUR PART NUMBER

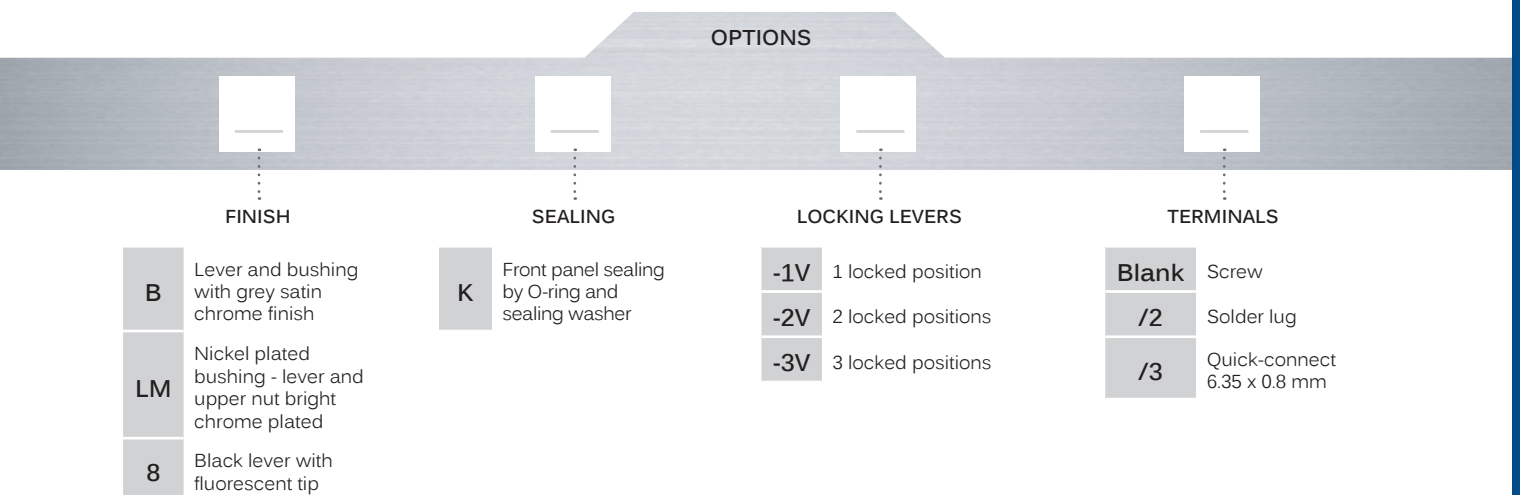
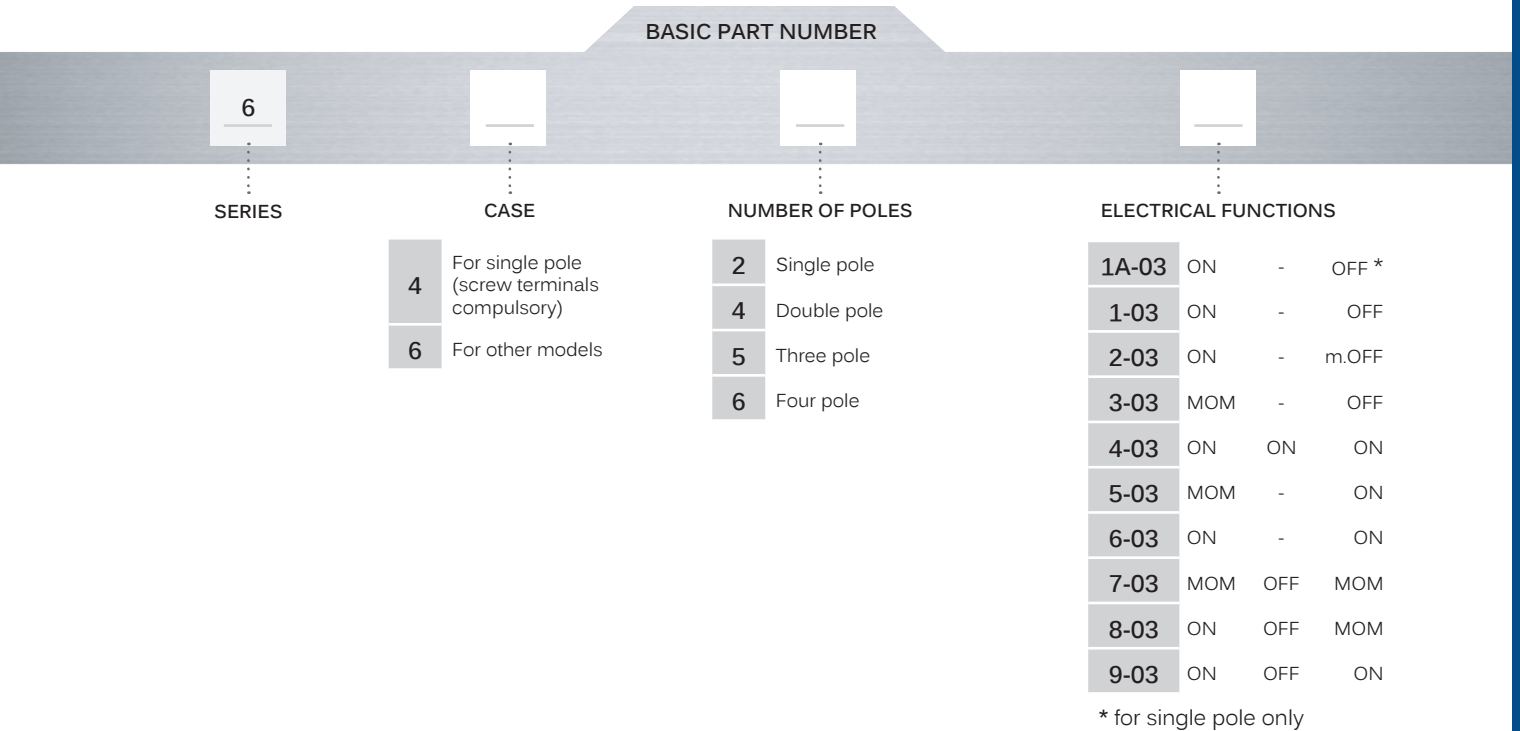

## ABOUT THIS SERIES

On the following pages, you will find successively basic part numbers of switches and options in the same order as in above chart.

- ⚠ **Notice** : please note that not all combinations of above numbers are available. Refer to the following pages for further information.
- ⚠ **Sealing boots** are available to protect the switches against dust and water. See "Sealing Boots" section of website.
- ⚠ **Mounting accessories** : standard hardware supplied with all models : 2 matt black nuts U41, matt black locking ring U12, zinc plated lockwasher U13. They are presented in the "Hardware" section of website.

# 6000 series

Toggle switches for rugged and demanding applications

## SCREW TERMINALS - SINGLE POLE



6421A-03	I ON	-	II OFF
----------	------	---	--------

→ KEYWAY

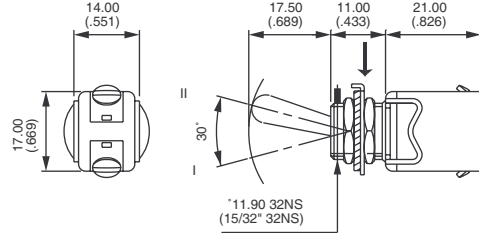

## SCREW TERMINALS - DOUBLE POLE



	III 2-1	II	I 2-3
	5-4		5-6
6641-03	ON	-	OFF
6642-03	ON	-	mom.OFF
6643-03	MOM	-	OFF
6644-03 ▲	ON	ON	ON
6645-03	MOM	-	ON
6646-03	ON	-	ON
6647-03	MOM	OFF	MOM
6648-03	ON	OFF	MOM
6649-03	ON	OFF	ON

→ KEYWAY

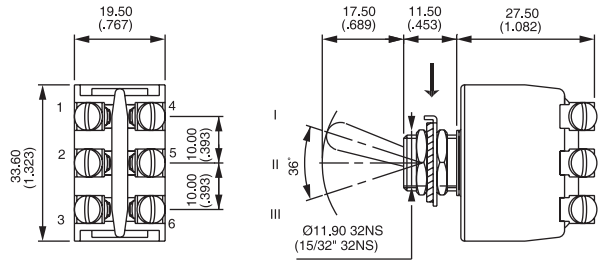

▲ Function 4 : SP in DP case, see "Technical information" on website.

## SCREW TERMINALS - THREE POLE



	III* 2-1	II	I** 2-3
	5-4		5-6
	8-7		8-9
6651-03	ON	-	OFF
6652-03	ON	-	mom.OFF
6653-03	MOM	-	OFF
6655-03	MOM	-	ON
6656-03	ON	-	ON
6657-03	MOM	OFF	MOM
6658-03	ON	OFF	MOM
6659-03	ON	OFF	ON

\* (2-1) (5-4) (8-7) \*\* (2-3) (5-6) (8-9)

→ KEYWAY

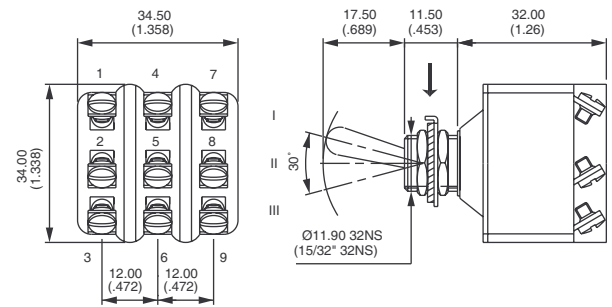

## SCREW TERMINALS - FOUR POLE



	III* 2-1	II	I** 2-3
	5-4		5-6
	8-7		8-9
	11-10		11-12
6661-03	ON	-	OFF
6662-03	ON	-	mom.OFF
6663-03	MOM	-	OFF
6664-03 ▲	ON	ON	ON
6665-03	MOM	-	ON
6666-03	ON	-	ON
6667-03	MOM	OFF	MOM
6668-03	ON	OFF	MOM
6669-03	ON	OFF	ON

\* (2-1) (5-4) (8-7) (11-10) \*\* (2-3) (5-6) (8-9) (11-12)

→ KEYWAY

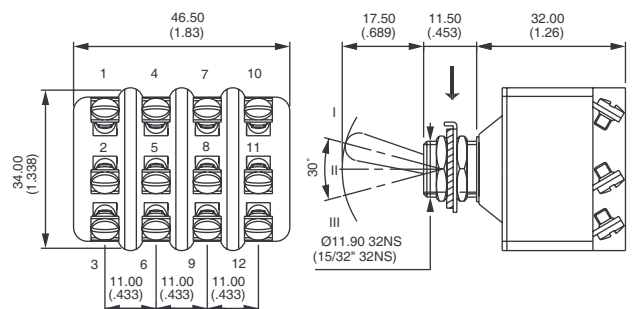

▲ Function 4 : SP in DP case, see "Technical information" on website.

# 6000 series

Toggle switches for rugged and demanding applications

## FINISH

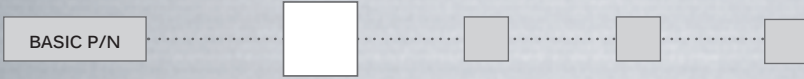

- B** Lever and bushing with grey satin chrome finish
- LM** Nickel plated bushing - lever and upper nut bright chrome plated
- 8** Black lever with fluorescent tip

## SEALING

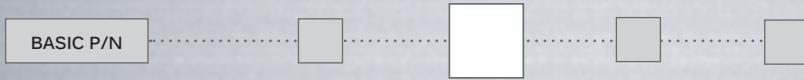

- K** Front sealing by O-ring and sealing washer. Protects the switch against water and dust. Panel seal withstands 1 bar pressure and remains sealed even when switch is operated.

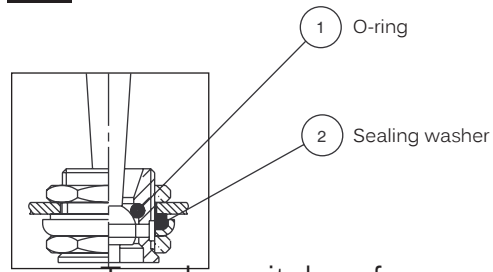

Toggle switches for rugged demanding applications

## LOCKING LEVERS

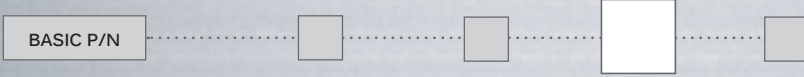

- 1V** 1 locked position
- 2V** 2 locked positions
- 3V** 3 locked positions

→ KEYWAY

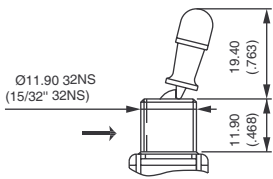

-1V

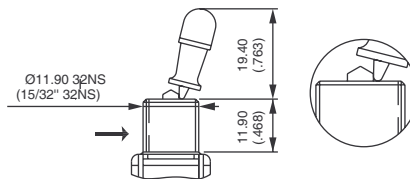

-2V

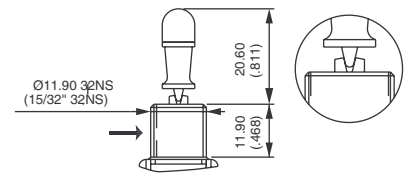

-3V

## TERMINALS

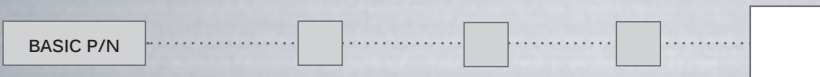

- Blank** Screw terminals (compulsory for single pole models)
- /2** Solder lug terminals
- /3** Quick-connect terminals 6.35 x 0.8 (.250 x .031)

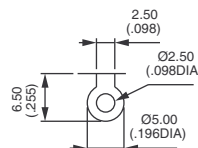

/2

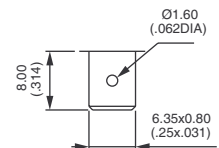

/3

# 6000 series

Toggle switches for rugged and demanding applications

## NEOPRENE PROTECTION CAPS

**To be ordered separately.**

Example : PROTECTION CAP U58

These caps are designed to insulate terminals against electrical short circuit.

- U58** For 1-pole models
- U120** For 2-pole models
- U46** For 3-pole models
- U47** For 4-pole models

