

PBA series

Piezo switches Ø 19 mm



DISTINCTIVE FEATURES

Bushing diameter 16 (.630), 19 (.748), 22 (.866) or 30 mm (1.181)

Sealed to IP68 and IP69K (switches mounted on panel)

Easy to clean metal surface

Very long life expectancy

Ring illumination



ENVIRONMENTAL SPECIFICATIONS

- Sealing : IP68 per IEC 60529, IP69K per DIN 40050-9 (switches mounted on panel)
- Vibration resistance : 10-500 Hz / 10 g per IEC 60068-2-6
- Operating temperature : -40 °C to +75 °C (-40 °F to + 167 °F)
- EMC compatibility according to EN 61058-1 for the whole range
- EMC compatibility according to EN 61000-4 & EN61000-6-2 for model 1A (code 002)
- Extreme thermal shock may briefly trigger the switch



ELECTRICAL SPECIFICATIONS

- Max. current/voltage rating with resistive load :
 - Function A : standard 200 mA 24 VAC/DC - option 1 A 24 VAC/DC
 - Function B : standard 100 mA 24 VAC/DC
- Switch resistance ON : 10 Ω max.
- Switch resistance OFF : 5 MΩ min.
- Life expectancy : 50 million cycles
- LED consumption : 20 mA max. (functions A-B)
- Power consumption for function 1 :
 - non-illuminated 10 mA - illuminated 30 mA



GENERAL SPECIFICATIONS

- Operating force : 2 to 6 N
- Torque : 2.5 Nm min. - 3 Nm max.

The company reserves the right to change specifications without notice.

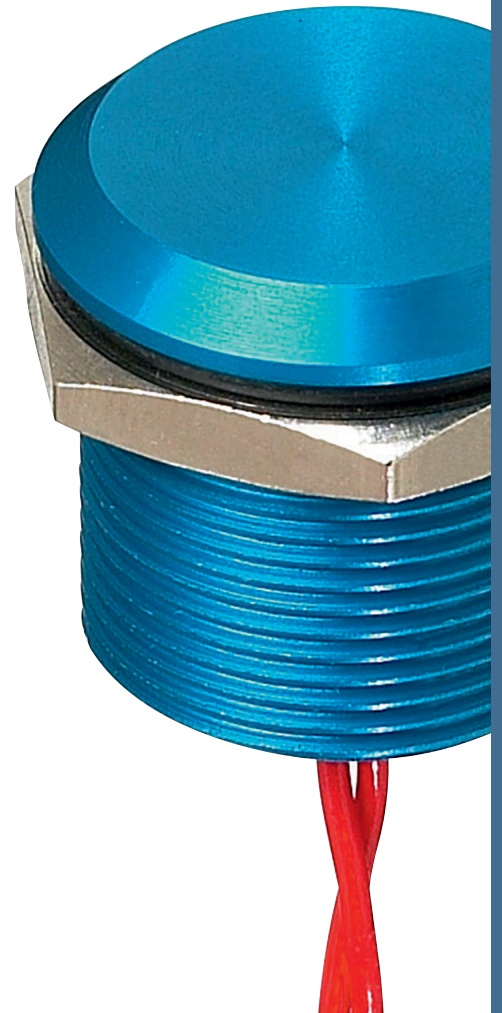
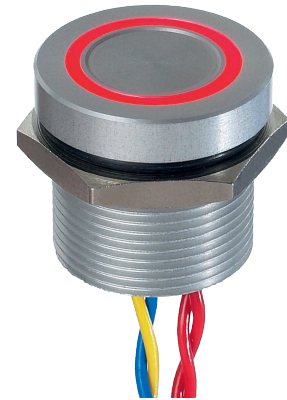

PBA series

Piezo switches Ø 19 mm



MATERIALS

- Case : aluminum, anodized or stainless steel 316L
- Multi-wire leads section 0.22 mm² length 300 mm, twisted by pair
- Cable, length 300 mm, section depending on switch model
- PC terminals : bronze, tin plated

APEM products may be recycled at end-of-life for the re-claiming of valuable metal components.

Note : to maintain the ESD performance, always add a ground washer when the panel is made of non-conductive material (PVC, polycarbonate).
For part numbers, see "Mounting accessories" on the following pages.



SEALING

SEALING IP68

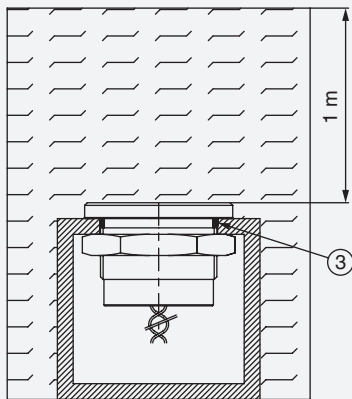

Continuous immersion in water IP68 test conditions

Continuous immersion in water
(1 m, 24 hours)

SEALING IP69K

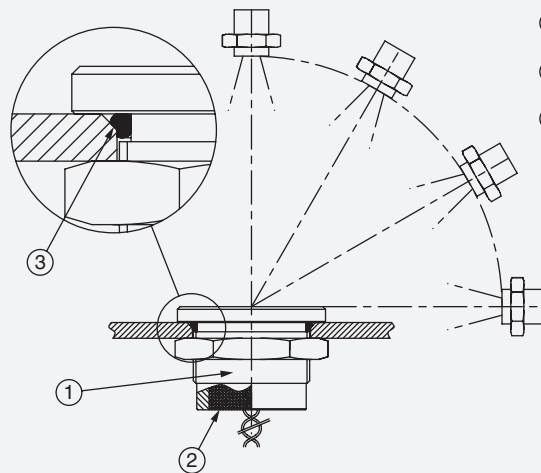

High pressure, high temperature wash down IP69K test conditions

- . Pressure : 80 - 120 bars
- . Distance : 15 cm
- . Temperature : 80 °C ± 5 °C (176 °F ± 41 °F)
- . Flow : 14 - 16 l/mn
- . Duration : 30 seconds per position



PANEL CUT-OUT

MODELS Ø19 (.748)





ELECTRICAL FUNCTIONS

FINGER PRESSURE APPLIED TO SWITCH

1 : pressure / 0 : no pressure

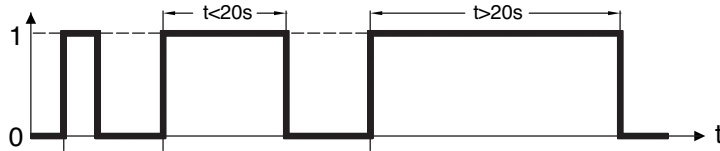

OUTPUT

1 : closed output / 0 : open output

Momentary NO (pulse)

No external power supply required

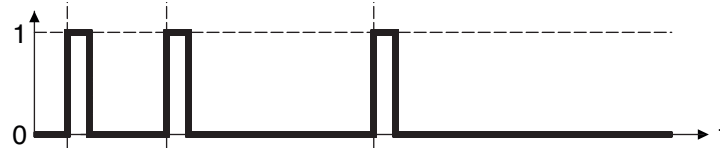

Momentary NC (pulse)

No external power supply required

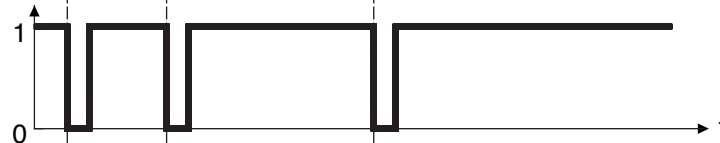

Latching (ON - OFF)

Requires external power supply

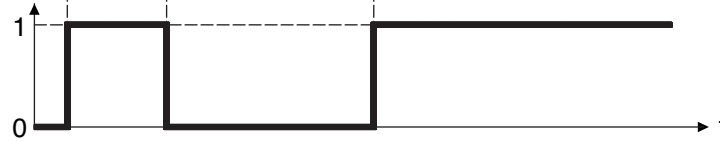

WIRING DIAGRAMS

	Non-illuminated	1 LED *	2 LEDs	3 LEDs
Momentary NO				
Momentary NC				
Latching (ON - OFF)				

Legend : C : yellow, D : blue, B : black , A : same color as LED * LED color is indicated by protective resin color on bottom of unit.

PBA series

Piezo switches Ø 19 mm

BUILD YOUR PART NUMBER

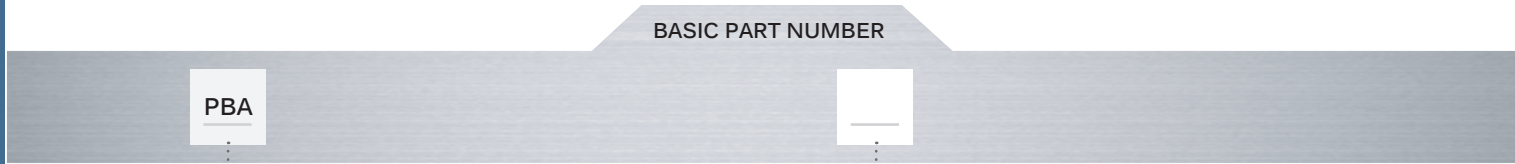

PBA

SERIES

BASIC PART NUMBER

BUSHINGS / OPERATORS

- R9** Flat operator, height 3 (.118)
- RA** With chamfer, height 3 (.118)

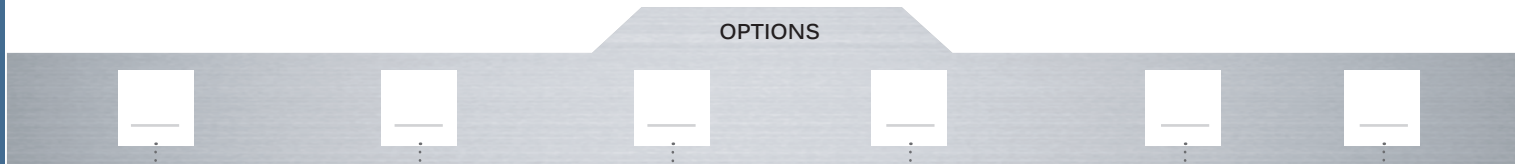

OPTIONS

ELECTRICAL FUNCTIONS

- A** NO (pulse)
- B** NC (pulse)
- 1** ON - OFF (requires external power supply - cannot be combined with T5 operator - illumination type W only)

TERMINALS

- F** Flying leads
- C** Cable
- P** Straight PC (T5 model, non-illuminated, functions A & B only)

COLORS / MATERIALS

- 0** Natural anodized
- 1** Blue anodized
- 2** Black anodized
- 3** Green anodized
- 5** Gold anodized
- 6** Red anodized
- B** Stainless steel 316L

Bold = standard

RATINGS

- 000** Standard
- 002** 1 A 24 VAC/DC (NO pulse only, function A)

TYPE OF ILLUMINATION/ VOLTAGE

- Blank** Non-illuminated
- A** Standard ring - 5 VDC
- N** Standard ring - 12 VDC
- K** Standard ring - 24 VDC
- W** Standard ring, microcontroller driven

LED COLORS

- Blank** Non-illum.
- 0B** Blue
- 0G** Green
- 0S** Red
- 0Y** Yellow
- 0W** White
- 2A** Red/green
- 2B** Red/yellow
- 2C** Red/blue
- 2D** Red/white
- 2E** Green/blue
- 2F** Green/yellow

LED COLORS (CONTINUED)

- 2G** Green/white
- 2H** Blue/yellow
- 2I** Blue/white
- 2K** Yellow/white
- 3A** Red/green/blue
- 3B** Red/green/yellow
- 3D** Red/green/white
- 3E** Red/blue/yellow
- 3F** Red/blue/white
- 3G** Red/yellow/white
- 3H** Green/blue/yellow
- 3I** Green/blue/white
- 3J** Green/yellow/white
- 3K** Blue/yellow/white

For options not listed above, please contact APEM.

ABOUT THIS SERIES

On the following pages, you will find successively basic part numbers of switches and options in the same order as in above chart.

 **Notice** : please note that not all combinations of above numbers are available. Refer to the following pages for further information.

 **Mounting accessories** : standard hardware supplied : 1 hex nut 10-855-5 (22mm ac. flats) and 1 O-ring. Always add a ground washer U5736 (Ø19 mm) when the panel is non-conductive (PVC, polycarbonate).

PBA series

Piezo switches \varnothing 19 mm

\varnothing 19 (.748) - NON-ILLUMINATED OPERATOR HEIGHT 3 MM



Flat

PBAR9

With chamfer

PBARA

Wire colors : see "Wiring diagrams".

\varnothing 19 (.748) - ILLUMINATED RING OPERATOR HEIGHT 3 MM



Flat

PBAR9

With chamfer

PBARA

Wire colors : see "Wiring diagrams".

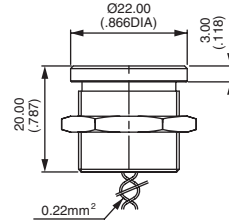

R9

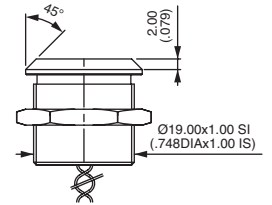

RA

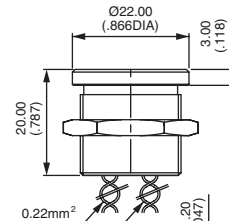

R9

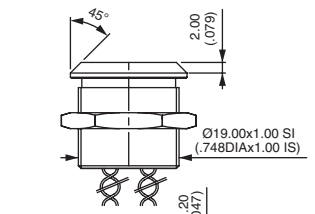

RA

ELECTRICAL FUNCTIONS



- A NO pulse
- B NC pulse
- 1 ON - OFF - Requires external power supply - Cannot be combined with T5 operator - Illumination type W only.

TERMINALS



- F Flying leads
- C Cable
- P Straight PC (T5 model, non-illuminated, functions A and B only)

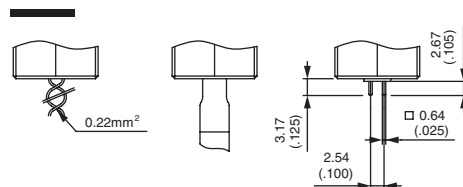

PBA series

Piezo switches Ø 19 mm

CASE COLORS / MATERIALS



- 0 **Natural anodized aluminum**
- 1 Blue anodized aluminum
- 2 **Black anodised aluminum**
- 3 Green anodized aluminum
- 5 Gold anodized aluminum
- 6 Red anodised aluminum
- B **Stainless steel 316L**

Bold = standard



0 1 2 3 5 6 B

RATINGS



- 000 Standard
- 002 1 A 24 VAC or DC (NO pulse only, function A)

TYPE OF ILLUMINATION / VOLTAGE



O

- Blank Non-illuminated
- A Thin ring - 5 VDC
- N Thin ring - 12 VDC
- K Thin ring - 24 VDC
- W Thin ring - µcontroller driven

PBA series

Piezo switches Ø 19 mm

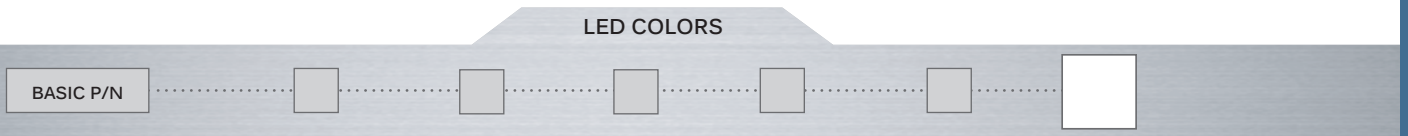

Blank Non-illuminated

Integrated LED resistor

Illuminated 1 LED *

0B : blue - **0G** : green - **0S** : red - **0Y** : yellow - **0W** : white

Illuminated 2 LEDs

2A : red/green - **2B** : red/yellow - **2C** : red/blue - **2D** : red/white - **2E** : green/blue - **2F** : green/yellow - **2G** : green/white

2H : blue/yellow - **2I** : blue/white - **2K** : yellow/white

Illuminated 3 LEDs

3A : red/green/blue - **3B** : red/green/yellow - **3D** : red/green/white - **3E** : red/blue/yellow - **3F** : red/blue/white

3G : red/yellow/white - **3H** : green/blue/yellow - **3I** : green/blue/white - **3J** : green/yellow/white - **3K** : blue/yellow/white

* LED color is indicated by protective resin color on bottom of unit.



0B



0G



0S



0Y



0W