

M3950/17 & M83731/25

QPL listed toggle switches - threaded bushing \varnothing 11,9 (15/32)

Distinctive features

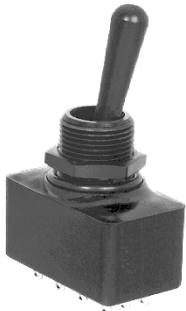

Approval and lists

M3950/17
M83731/25

QPL listed

This range of professional toggle switches is suitable for use in military and other high specification environments.

Contacts

Highly reliable contacts suitable for low level applications (10mA 50mV - 10 μ A 5VDC min.) or power applications (2A 250VAC - 4A 125VAC - 4A 30VDC max.)

Pinned lever

The base of the switch lever is pinned to the bushing, thus earthing the lever to the bushing. This also provides strain relief to protect the switch if accidentally knocked.

Double shell case

For high mechanical strength and high electrical insulation.

Compact size

The small rear end of the switch allows space saving behind the panel.

Finish

Matt black finish on body, bushing, lever and hardware.

Sealing

Panel sealed to IP 67, these switches are frontal sealed by two O-rings and have full rear end sealing.

Accessories

A comprehensive range of protection boots (both full and half length), locking levers and security caps are available.



M3950/17 & M83731/25

QPL listed toggle switches - threaded bushing Ø 11,9 (15/32)

Specifications

ELECTRICAL SPECIFICATIONS

- Max. current/voltage rating with resistive load : 2A 250VAC - 4A 125VAC - 4A 28VDC
- Minimum load : 10mA 50mV, 10µA 5VDC
When used above 300mA 28VDC, the gold plating is removed on contact areas and is considered only as a protection against oxidation during storage.
- Initial contact resistance : 10 mΩ max.
- Insulation resistance : 1.000 MΩ min. at 500VDC
- Dielectric strength :
 - 1.000 Vrms 50 Hz min. between terminals
 - 2.000 Vrms 50 Hz min. between poles
 - 2.000 Vrms 50 Hz min. between terminals and frame
- Contact bounce : 2 ms max.
- Electrical life :
 - At 2A 250VAC - 4A 28VDC :
20.000 cycles (10.000 for functions 5, 4-1R, 4-2R)
 - At low level (50mV 10mA) :
150.000 cycles (switches with 2 maintained positions)
100.000 cycles (switches with 3 maintained positions)
50.000 cycles (momentary functions 7, 8, 4-1R, 4-2R, 5)

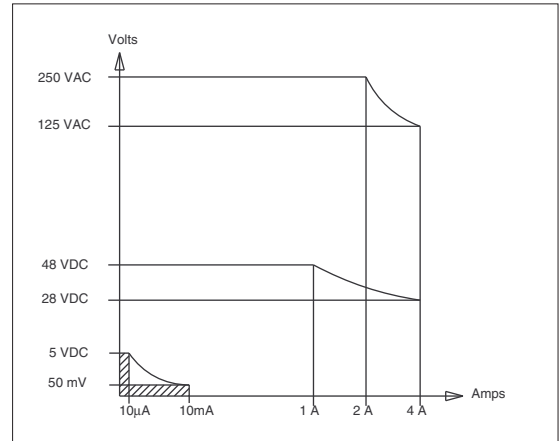

MATERIALS

- Case: diallylphthalate (DAP) with plastic external shell (epoxy sealed)
- Actuator: brass, black chrome plated
- Bushing : brass, black chrome plated
- Contacts : solid rivet - gold plated silver/nickel alloy

SEALING

- Front panel sealing by two O-rings
Flatted bush for precise orientation
- Panel seal withstands 1 bar pressure and remains sealed even when the switch is operated.
- Epoxy sealed terminals
- Splash-proof case

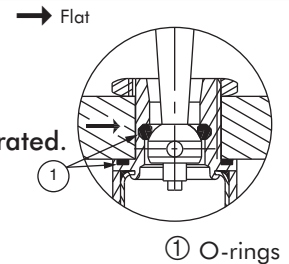

GENERAL SPECIFICATIONS

- Torque : 1,50 Nm (1.10 Ft.lb) max. applied to nut
- Panel thickness : 8 mm (.314) max. - 3 mm (.118) min.
- Shock test : 50g - 11ms (IEC 68-2-27)
- Vibrations : 10-500 Hz - 10g (IEC68-2-6)
- Operating temperature : -40°C to +85°C
- Humidity test : 56 days, 93 % R.H., 40°C (IEC 68-2-3)
- Salt spray test : 96 hours (IEC 68-2-11)

APPROVALS

All models within this range are QPL listed and comply with M3950 and M83731

M3950/17 & M83731/25

QPL listed toggle switches - threaded bushing Ø 11,9 (15/32)

Overview

MODEL
STRUCTURE

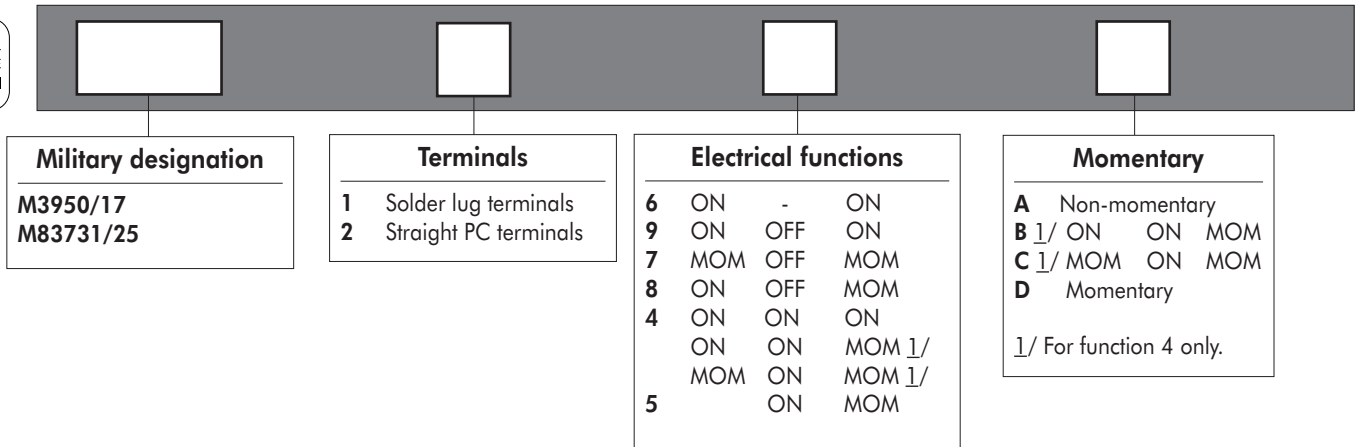

OPTIONS

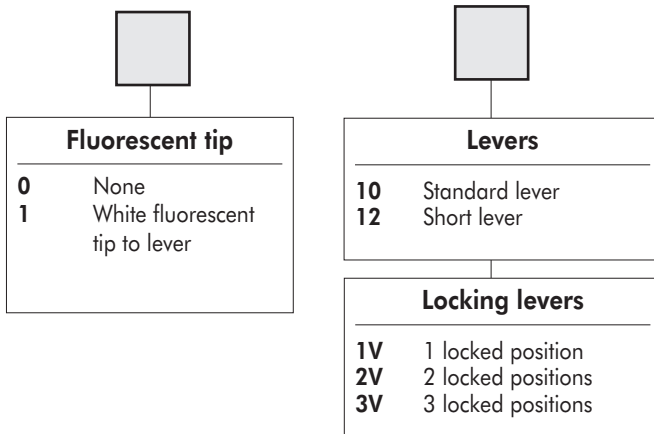

ABOUT THIS SERIES

On the following pages, you will find successively :

- model structure of switches
- options in the same order as in above chart

Dimensions : first dimensions are in mm while inches are shown as bracketted numbers.



Sealing boots can be used to further protect the switches against dust and water. They are presented in section H.



Mounting accessories : standard hardware supplied with all models : 1 hex nut 14 mm (.551) across flats, part number U41. This nut is presented after model structure of switches.

Security caps are available to prevent inadvertent lever operation. They are presented in section I.



Packaging unit : 20 pieces

M3950/17 & M83731/25

QPL listed toggle switches - threaded bushing \varnothing 11,9 (15/32)

Terminations

- Solder lug or straight PC terminals

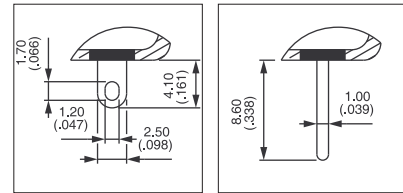

Solder lug terminals - three pole

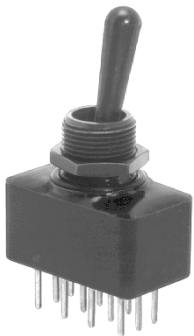

M3950/1726
M3950/1729
M3950/1727
M3950/1728

I	II	III
ON	-	ON
ON	OFF	ON
MOM	OFF	MOM
ON	OFF	MOM

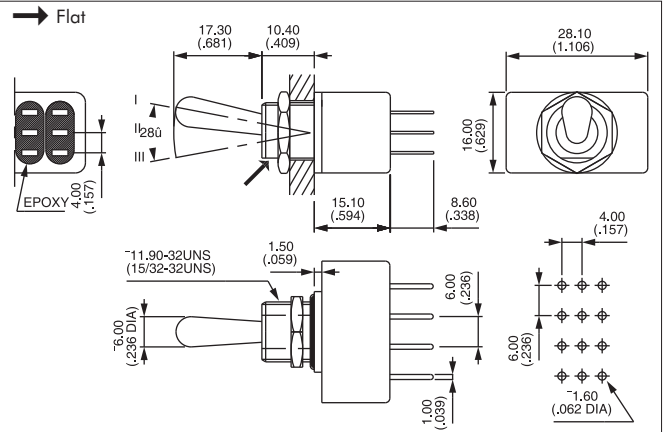

FLUORESCENT TIP

- Blank** None
- 0.38** White fluorescent tip.
Becomes luminous when submitted to ultra-violet rays.

Standard lever

Locking lever

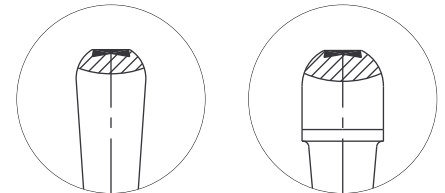

LEVERS / LOCKING LEVERS

Levers

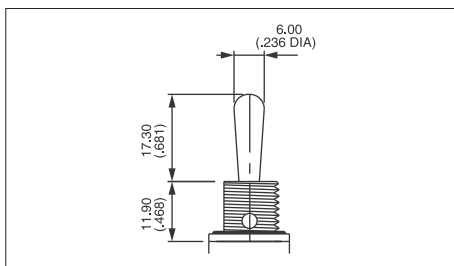

Standard (leave blank)

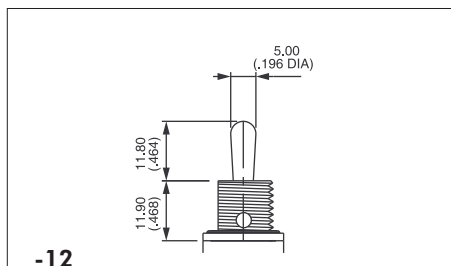

-12
Short lever

Sealing boots : see section H.
Security caps : see section I.

Locking levers

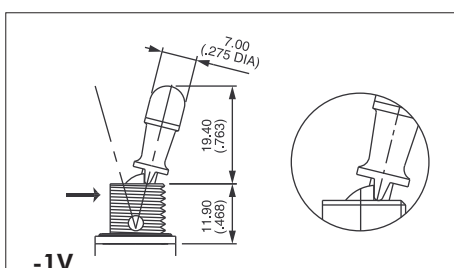

-1V
1 locked position (function 6)

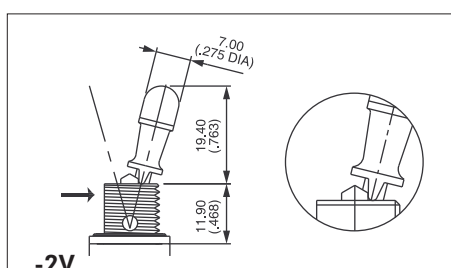

-2V
2 locked positions (function 6)

→ Flat

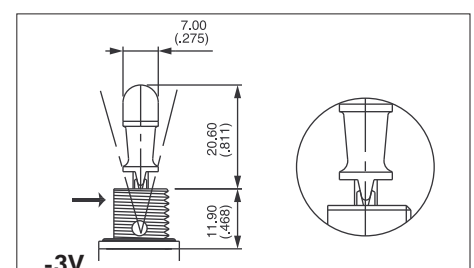

-3V
3 locked positions (functions 9 and 4)